

package:  
 with one silica bag in a poly bag,  
 into one inner carton, With UPCA label  
 Inner carton should be made of thick cardboard  
 5 inner cartons per master box.

Bills of Material:

4	WOOD-SCREW	Steel	63	0.71	44.78	PART	1
3	DIVIDER	Birch	1	1907.36	1907.36	PART	1
2	BAR	Birch	1	229.20	229.20	PART	1
1	BASE	PLY Wood	1	1409.33	1409.33	PART	1
NO.	ITEM#	MATERIAL	QTY	UNIT	TOTLE	TYPE	ASSY
				WEIGHT			LEVEL
<b>hardware resources</b>		ITEM#		MATERIAL:			
PROPRIETARY AND CONFIDENTIAL		KNIFE-BLOCK		WEIGHT:		9	
THE INFORMATION CONTAINED IN THIS DRAWING IS THE SOLE PROPERTY OF HARDWARE RESOURCES INC. ANY REPRODUCTION IN PART OR AS A WHOLE WITHOUT THE WRITTEN PERMISSION OF HARDWARE RESOURCES INC. IS PROHIBITED		FINISH:		PROJECTION:			
TOLERANCE UNLESS OTHERWISE SPECIFIED: X: MM ±0.20 XX: MM ±0.10 XXX: MM ±0.05 ANGULAR: ±0.5° DO NOT SCALE DRAWING		UNIT:	DRAWN BY:	DATE:			
		SIZE:	alan.liu	DATE:			
		PAGE 01	CHECKED BY:	DATE:			
			APPROVED BY:	DATE:			

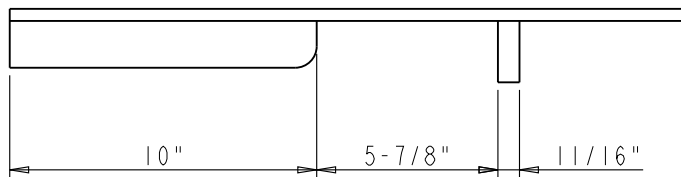
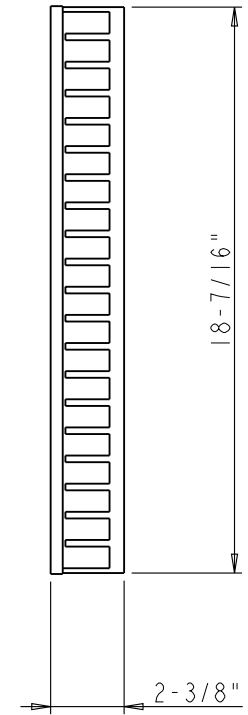
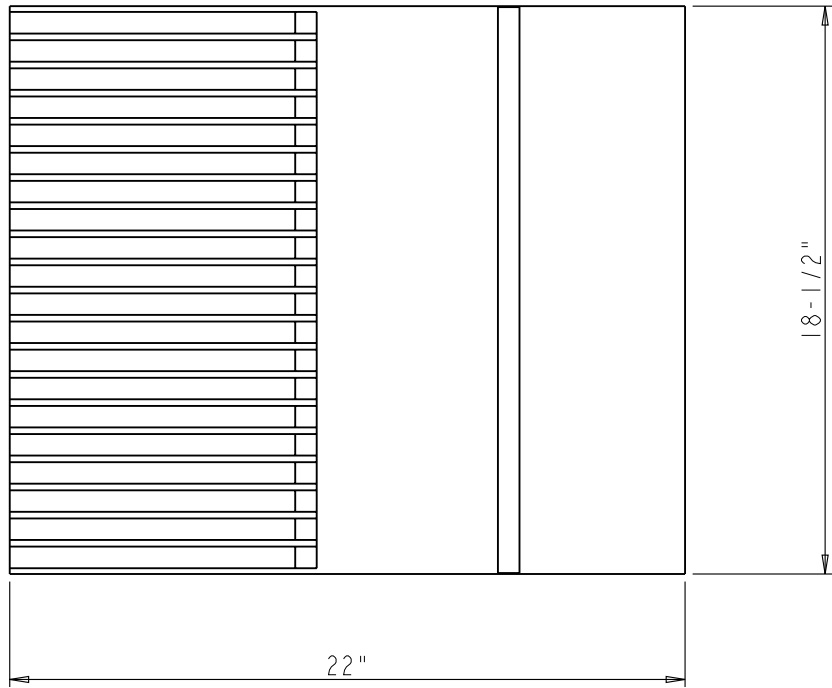

	ITEM: KNIFE-BLOCK		MATERIAL:			
	FINISH:		WEIGHT: 9			
<b>PROPRIETARY AND CONFIDENTIAL</b> THE INFORMATION CONTAINED IN THIS DRAWING IS THE SOLE PROPERTY OF HARDWARE RESOURCES INC. ANY REPRODUCTION IN PART OR AS A WHOLE WITHOUT THE WRITTEN PERMISSION OF HARDWARE RESOURCES INC. IS PROHIBITED.	TOLERANCE UNLESS OTHERWISE SPECIFIED: X : MM ±0.20 XX : MM ±0.10 XXX : MM ±0.05 ANGULAR: ±0.5° DO NOT SCALE DRAWING		UNIT: SIZE:	DRAWN BY: <i>alan.liu</i>	DATE:	
	PROJECTION:		CHECKED BY:	DATE:	DATE:	
	PAGE 02		APPROVED BY:	DATE:	DATE:	DATE:

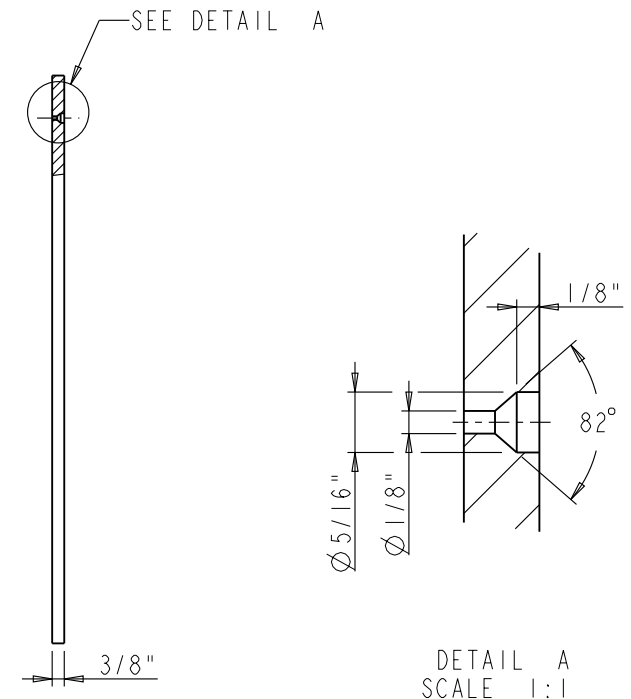
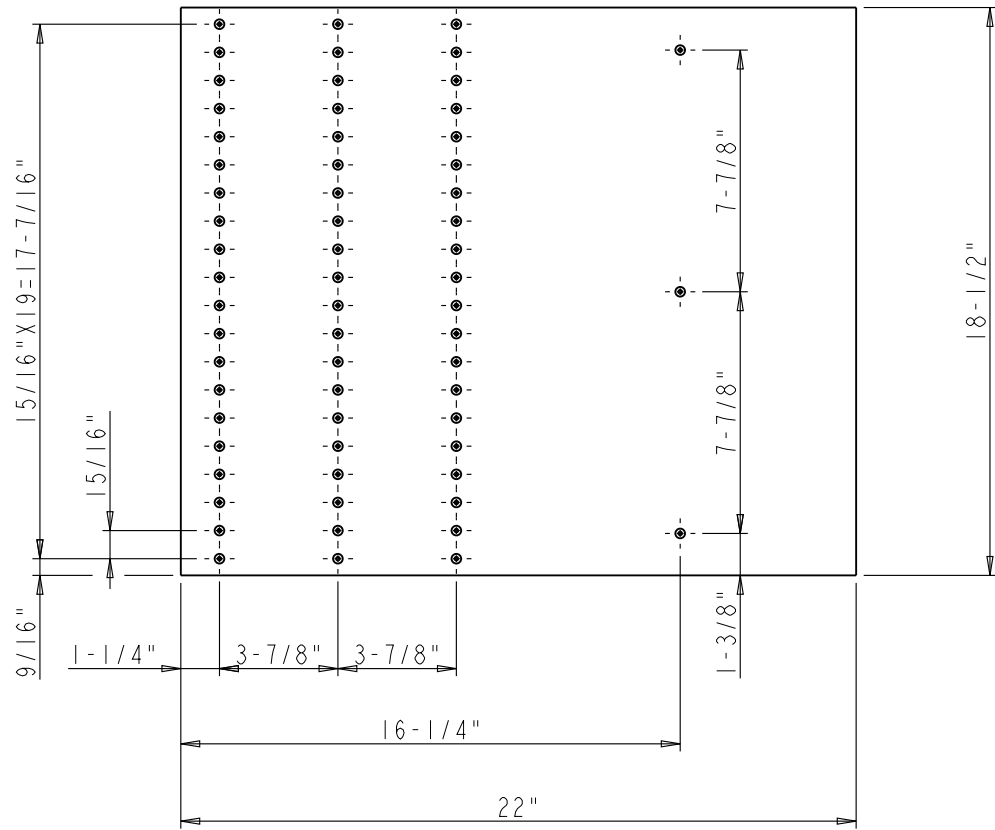

SECTION A-A

Specification:

1. Material: PLY wood with Birch veneer
2. Finish: Clear color

	ITEM: BASE		MATERIAL:		
	FINISH:		WEIGHT: 1409.33 g		
PROPRIETARY AND CONFIDENTIAL THE INFORMATION CONTAINED IN THIS DRAWING IS THE SOLE PROPERTY OF HARDWARE RESOURCES INC. ANY REPRODUCTION IN PART OR AS A WHOLE WITHOUT THE WRITTEN PERMISSION OF HARDWARE RESOURCES INC. IS PROHIBITED.	TOLERANCE UNLESS OTHERWISE SPECIFIED: X: MM ±0.20 XX: MM ±0.10 XXX: MM ±0.05 ANGULAR: ±0.5° DO NOT SCALE DRAWING		UNIT:	DRAWN BY: <i>alan.liu</i>	DATE:
	SIZE:	CHECKED BY:	DATE:		
	PAGE 03		APPROVED BY:	DATE:	
	PROJECTION:				

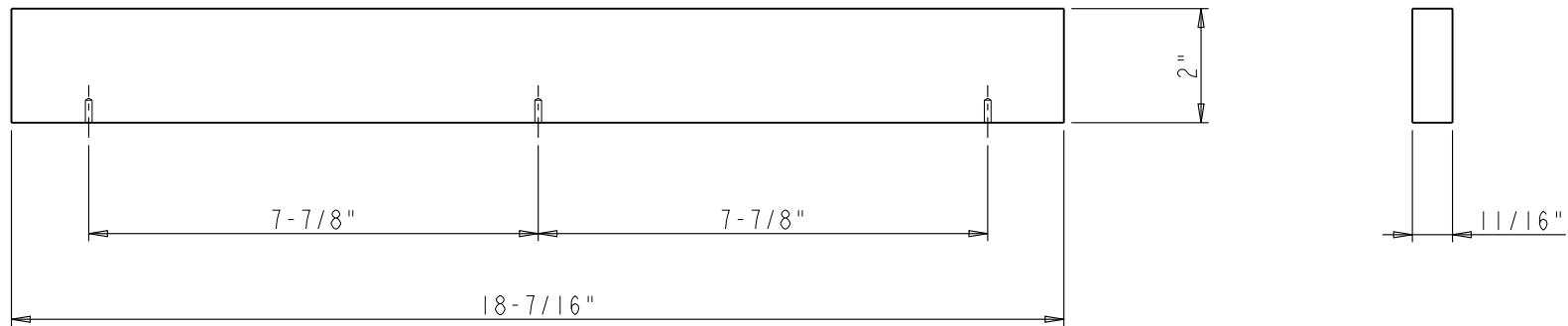

Specification:

1. Material: Birch
2. Finish: Clear color

	ITEM: BAR		MATERIAL:	
	FINISH:		WEIGHT: 229.20 g	
<b>PROPRIETARY AND CONFIDENTIAL</b> THE INFORMATION CONTAINED IN THIS DRAWING IS THE SOLE PROPERTY OF HARDWARE RESOURCES INC. ANY REPRODUCTION IN PART OR AS A WHOLE WITHOUT THE WRITTEN PERMISSION OF HARDWARE RESOURCES INC. IS PROHIBITED.	TOLERANCE UNLESS OTHERWISE SPECIFIED:		PROJECTION:	
	X: MM ±0.20	UNIT:	DRAWN BY: <i>alan.liu</i>	
	X.X: MM ±0.10	SIZE:	CHECKED BY:	
	X.XX: MM ±0.05	APPROVED BY:		DATE:
ANGULAR: ±0.5°	PAGE 04		DATE:	
DO NOT SCALE DRAWING				

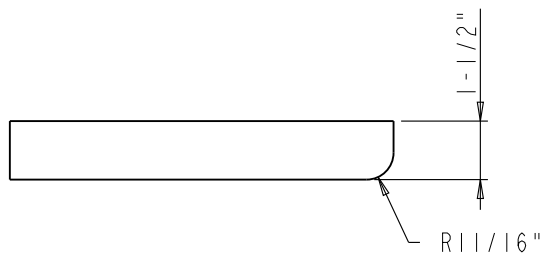
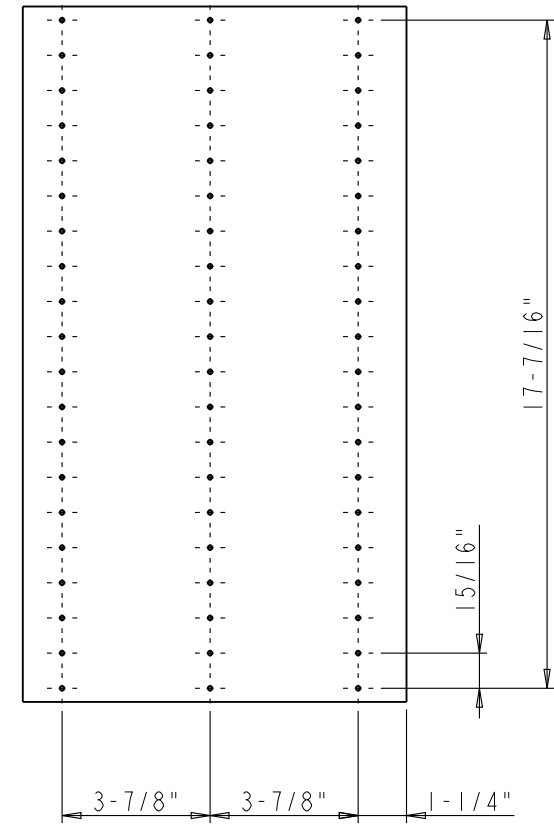
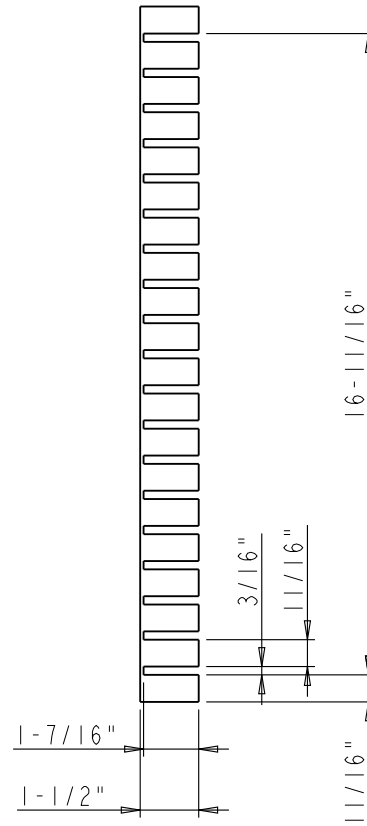
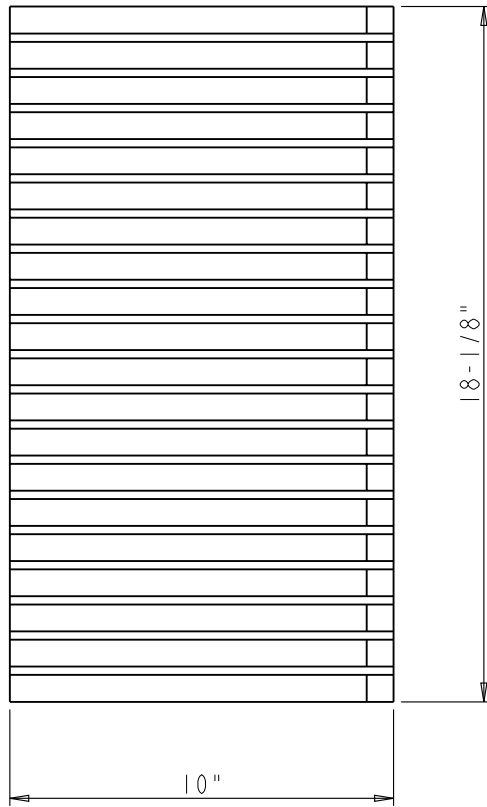

Specification:

1. Material: Birch
2. Finish: Clear color

	ITEM: DIVIDER		MATERIAL:		
	FINISH:		WEIGHT: 1907.36 g		
<b>PROPRIETARY AND CONFIDENTIAL</b> THE INFORMATION CONTAINED IN THIS DRAWING IS THE SOLE PROPERTY OF HARDWARE RESOURCES INC. ANY REPRODUCTION IN PART OR AS A WHOLE WITHOUT THE WRITTEN PERMISSION OF HARDWARE RESOURCES INC. IS PROHIBITED.	TOLERANCE UNLESS OTHERWISE SPECIFIED:		PROJECTION:		
	X : MM ±0.20 X.X : MM ±0.10 X.XX : MM ±0.05 ANGULAR: ±0.5° DO NOT SCALE DRAWING	UNIT:  SIZE:	DRAWN BY: <i>alan.liu</i>	DATE:	
	PAGE 05		CHECKED BY:  APPROVED BY:	DATE:	